

**PENTODE
 POWER AMPLIFIER**

Western Electric

DESCRIPTION

The 293A is a suppressor grid, power pentode having an indirectly heated cathode. It is designed for use as an audio-frequency power amplifier in Class A₁ service.

CHARACTERISTICS

Heater Voltage		10.0 volts
Plate Current	$\left. \begin{array}{l} E_b = E_{c2} = 180 \text{ volts;} \\ E_{c1} = -18 \text{ volts;} E_{c3} = 0 \end{array} \right\}$	15.8 milliamperes
Transconductance		1175 micromhos
Power Output		1.2 watts

GENERAL CHARACTERISTICS

ELECTRICAL DATA

Heater Voltage, A-C or D-C	10.0 volts
Heater Current	320 milliamperes
Direct Interelectrode Capacitances (without external shield)	
Grid to Plate	0.66 uuf
Input	6.2 uuf
Output	6.5 uuf

MECHANICAL DATA

Cathode	Coated Unipotential
Bulb	ST14
Base	Medium 6-pin
Mounting Position	Any
Dimensions and pin connections shown in outline drawing on Page 6	

MAXIMUM RATINGS, Design-Center Values

Plate Voltage	250 volts
Screen Grid Voltage	200 volts
Plate Dissipation	5 watts
Screen Grid Dissipation	1 watt
Cathode Current	30 milliamperes
Heater-Cathode Voltage	150 volts

TYPICAL OPERATING CONDITIONS AND CHARACTERISTICS

SINGLE TUBE AMPLIFIER — CLASS A₁

Plate Voltage	135	180	250 volts
Screen Grid Voltage	135	180	200 volts
Control Grid Voltage	-12	-18	-18 volts
Peak A-F Grid Voltage	12	18	18 volts
Zero Signal Plate Current	12.5	15.8	21.5 milliamperes
Maximum Signal Plate Current	13.5	17.0	23.5 milliamperes
Zero Signal Screen Grid Current	1.9	2.7	3.5 milliamperes
Maximum Signal Screen Grid Current	3.2	5.2	5.6 milliamperes
Transconductance	1140	1175	1340 micromhos
Plate Resistance	95000	100000	100000 ohms
Load Resistance	11000	11500	12000 ohms
Maximum Signal Power Output	0.6	1.3	2.1 watts
Total Harmonic Distortion	9.7	11	10 per cent

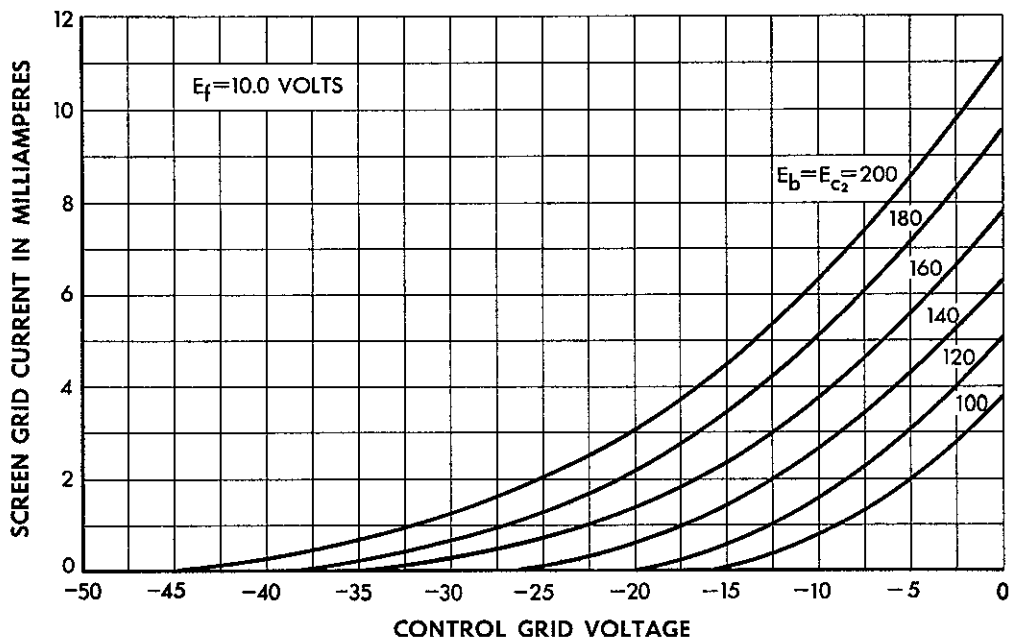
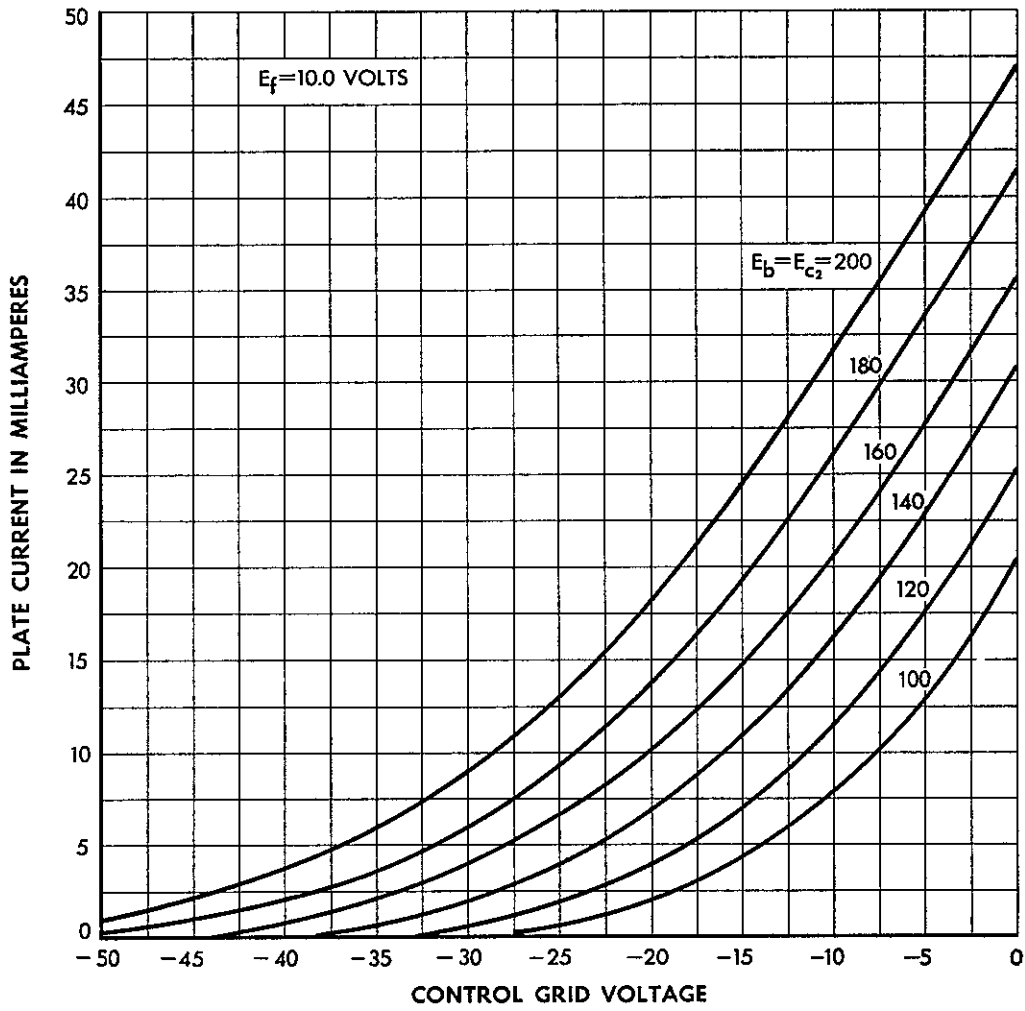

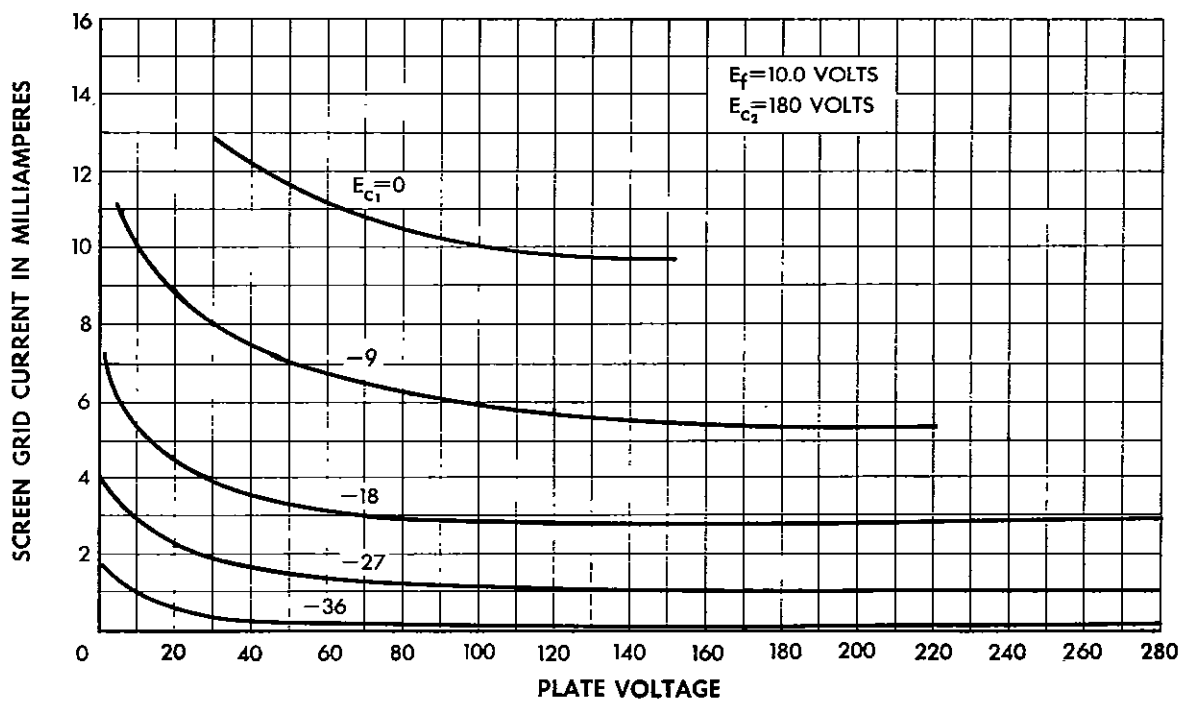
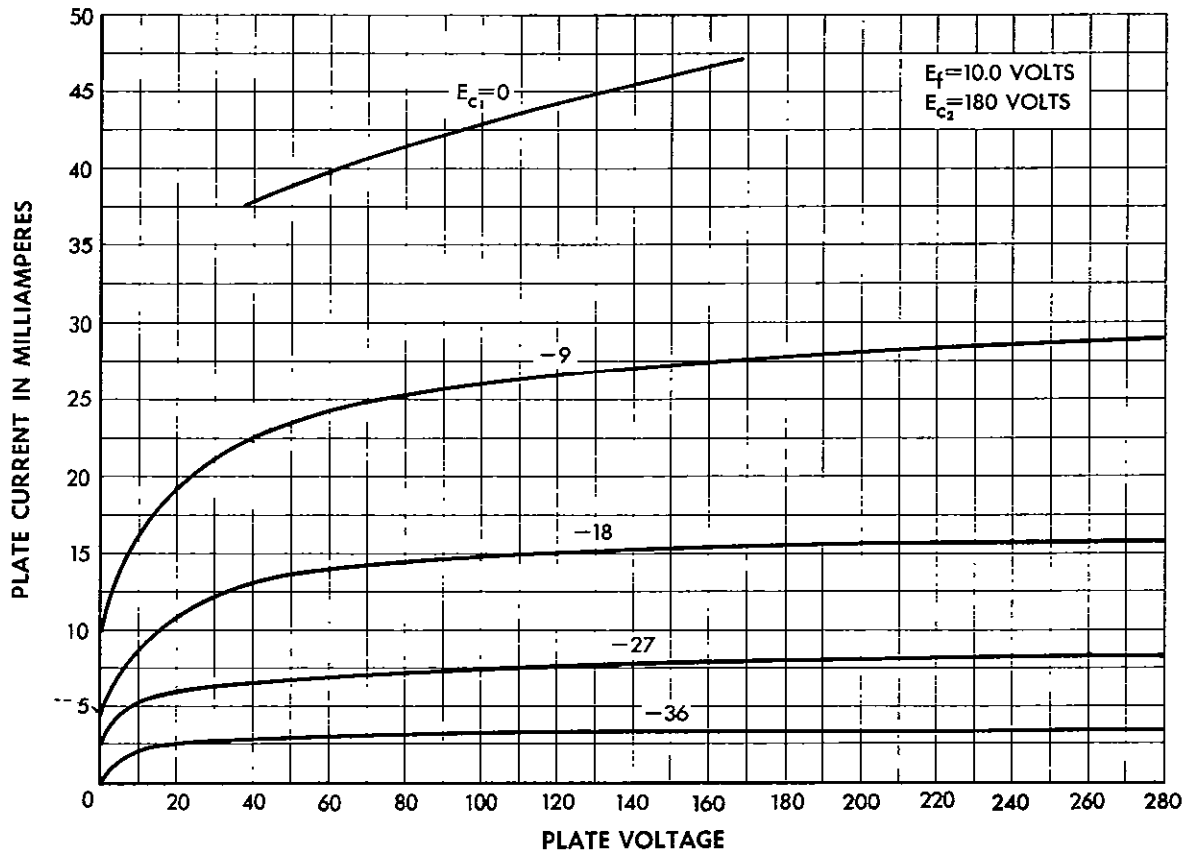

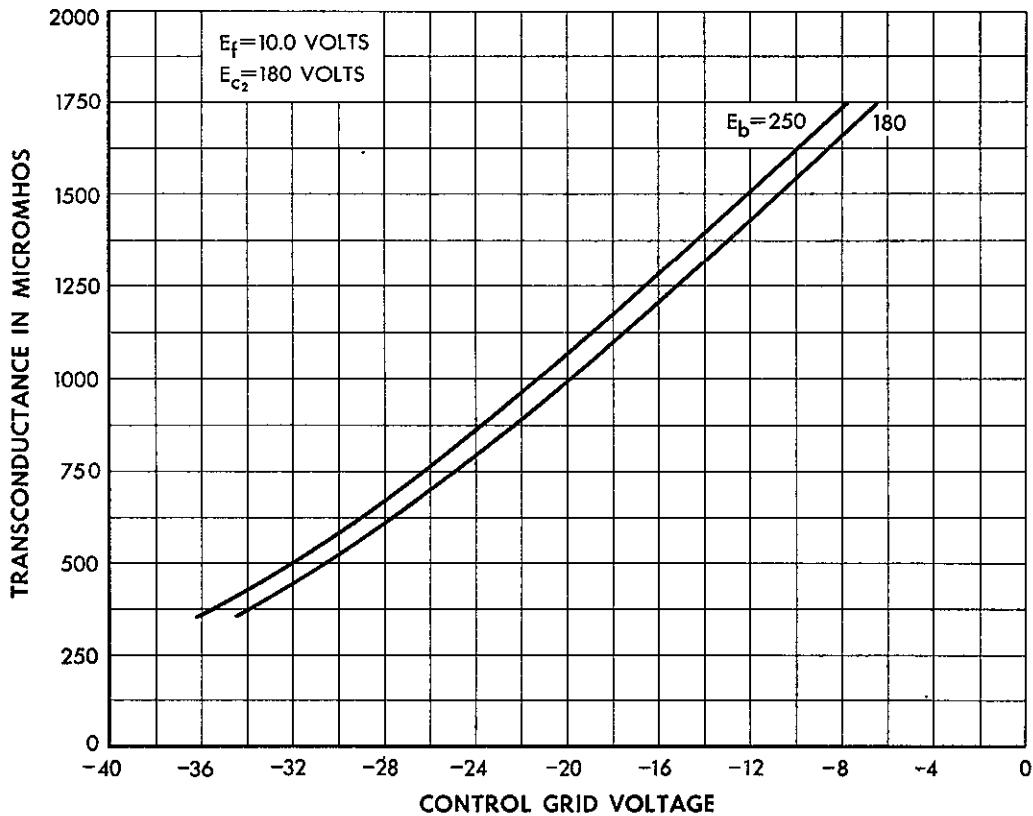
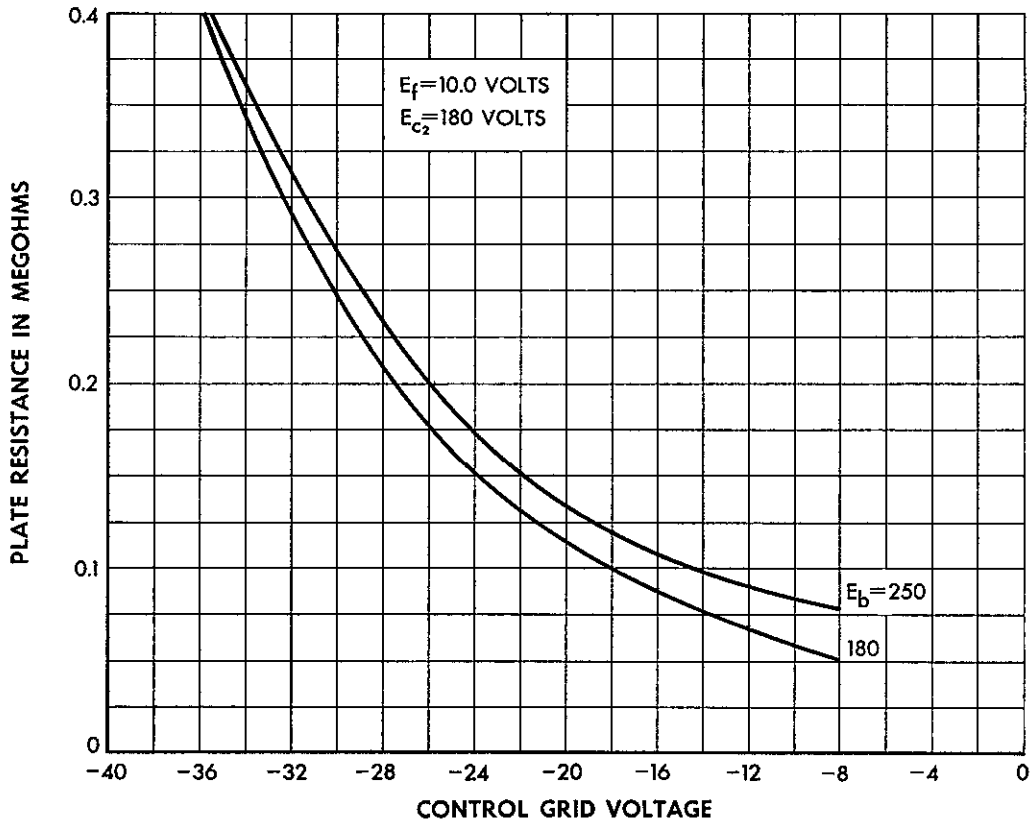

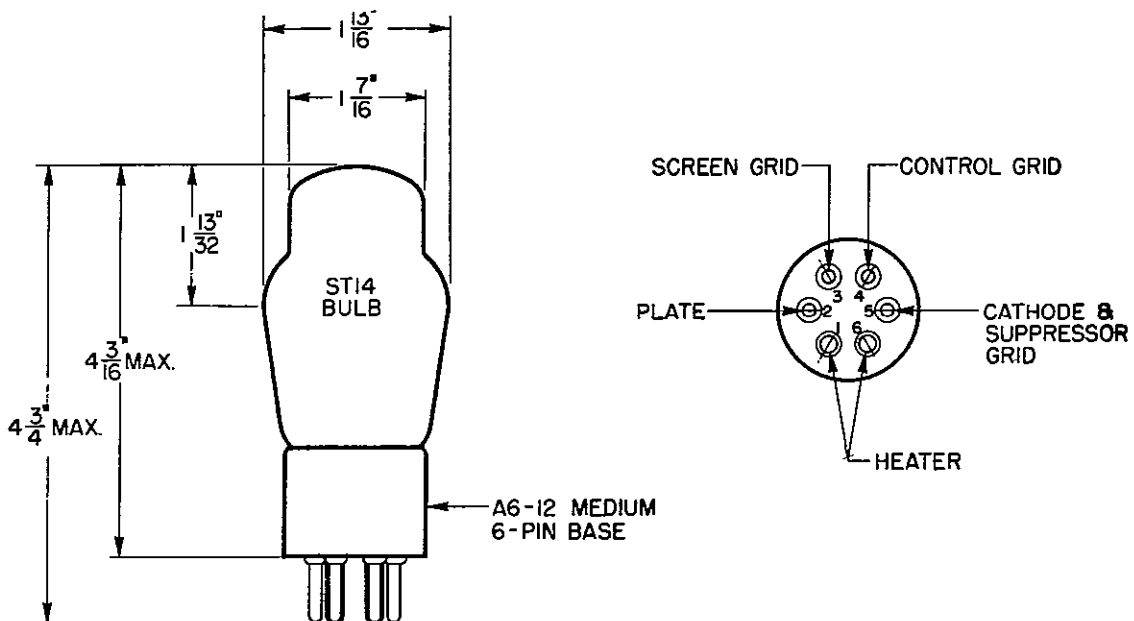
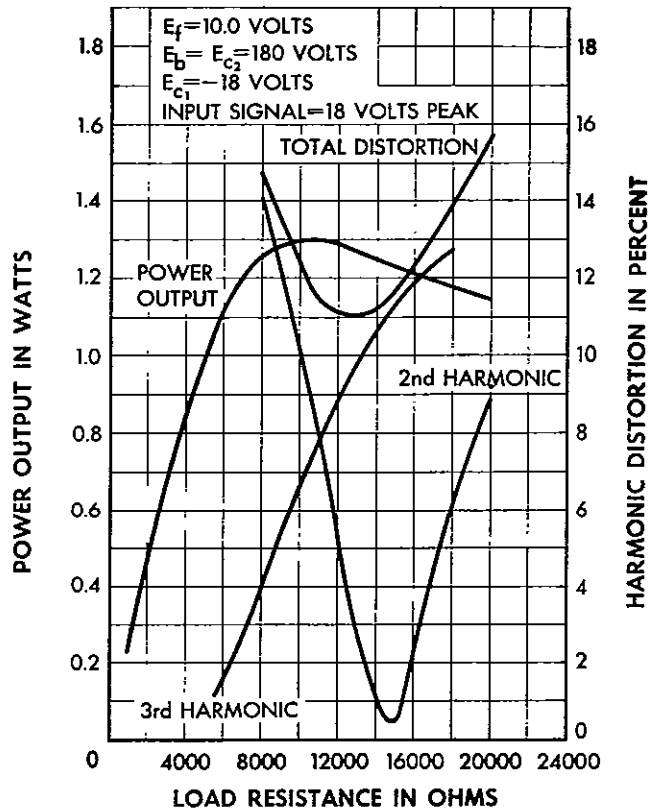

Western Electric

A development of Bell Telephone Laboratories, the research laboratories of the American Telephone and Telegraph Company and the Western Electric Company.